

Orbis I.S. TimeSaver® Base

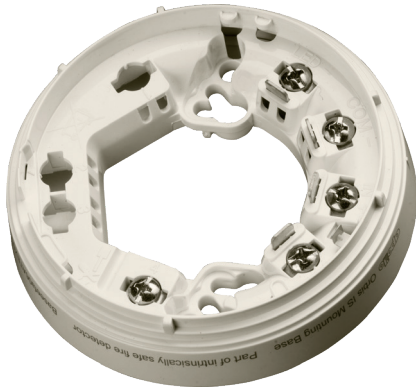

Orbis I.S. TimeSaver base terminals

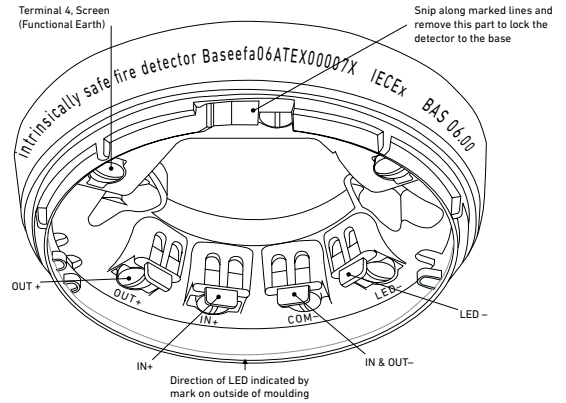

Orbis I.S. TimeSaver base dimensions

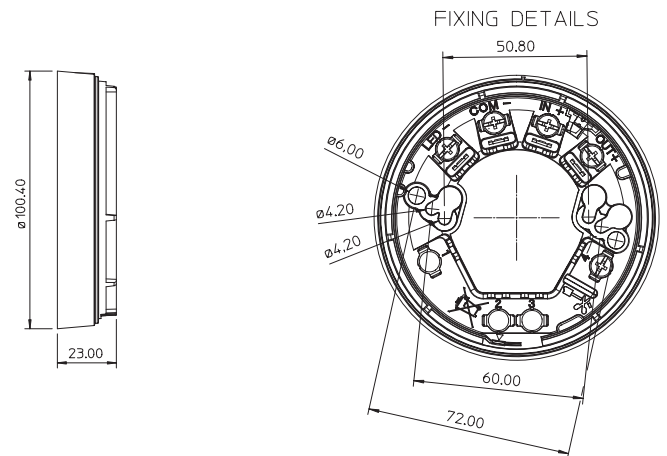

Marine Equipment Directive 2014/90/EU

The Orbis I.S. TimeSaver Base complies with the essential requirements of the Marine Equipment Directive 2014/90/EU.

Product overview

Product	I.S TimeSaver Base
Part No.	ORB-MB-50018-APO

Approvals



Product information

The Orbis Intrinsically Safe (I.S.) TimeSaver Base has been designed to make installation fast and simple.

The terminal screws are captive screws and will not fall out of the terminals. The base is supplied with the screws unscrewed in order to avoid unnecessary work for the installer.

If it is required that all detectors are fitted with their LEDs facing the same direction, the bases must be fitted to the ceiling observing the marking on the exterior which indicates the position of the LED.

- Grouped terminals to make wiring easy
- Multiple fixing centres
- LED alignment mark
- Cable stripping guide

Orbis I.S. TimeSaver Base wiring diagram

Note: the earth terminal in the base is provided for convenience where continuity of a cable sheath or similar is required. It is not necessary for the correct operation of the detector nor is it provided as a termination point for a safety earth.
 If screened cable is used screen continuity should be maintained and the screen should be earthed only at one point. The earthing point should preferably be close to the safety barrier.
 The system complies with the requirements of the CPD only if wired using screened cable. For details of cable connections see BS EN 60079-14, section 12.2.2.

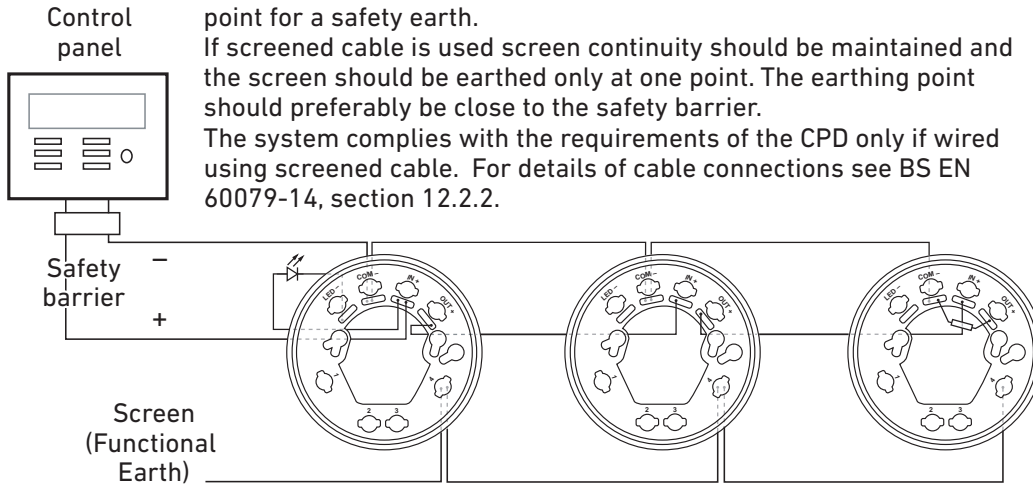

Orbis I.S. TimeSaver Base wiring diagram - three bases wired with a common LED

Note: the earth terminal in the base is provided for convenience where continuity of a cable sheath or similar is required. It is not necessary for the correct operation of the detector nor is it provided as a termination point for a safety earth.
 If screened cable is used screen continuity should be maintained and the screen should be earthed only at one point. The earthing point should preferably be close to the safety barrier.
 The system complies with the requirements of the CPD only if wired using screened cable. For details of cable connections see BS EN 60079-14, section 12.2.2.

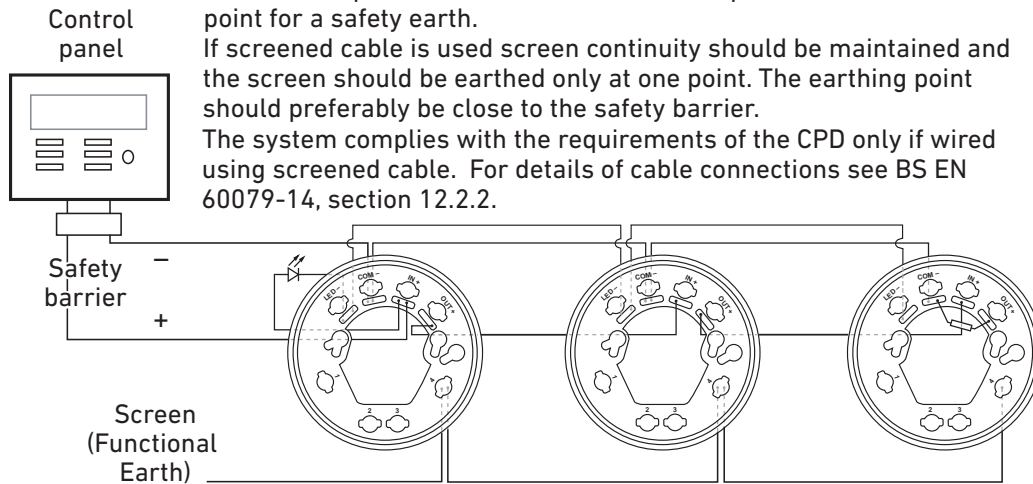

About Orbis I.S.

System design

The design of an intrinsically safe (I.S.) fire detection system should only be undertaken by engineers familiar with codes of practice for detection systems and hazardous area electrical systems. The relevant standards are BS 5839-1, BS EN60079 and BS EN 60079-14 respectively.

The fire detection performance of the Orbis I.S. range is the same as that of its standard counterparts but some electrical parameters are different.

The BASEEFA certification of Orbis I.S. devices covers their characteristics as components of an I.S. system and indicates that they can be used with a margin of safety in such systems. The certified system configurations allow for two types of safety barrier, each of which has its own advantages and disadvantages. A brief outline of each type is given in the paragraphs that follow:

Types of Safety Barrier

Single Channel 28 V/300 Ω Barrier

This is the most basic type of barrier and therefore the lowest in cost. Being passive devices, they also impose the minimum of restrictions on the operation of the fire detectors. This, single channel barriers are available either as positive or negative polarity where the polarity refers to the polarity of the applied voltage relative to earth. The significance of this is that one side of the barrier must be connected to a high-integrity (safety) earth. Although this earth connection has no effect on the operation of Orbis I.S. devices and is not needed for their correct operation, it may not be acceptable to the operation of the fire control panel. If the earth connection is not acceptable then the isolating barriers should be used.

Table 1: 28 V/300 Ω Single Channel Safety Barriers

Manufacturer	Type	Polarity	Mounting
Pepperl + Fuchs	Z728	+ve	DIN-Rail
Pepperl + Fuchs	Z828	-ve	DIN-Rail
Pepperl + Fuchs	Z428/Ex	+ve	DIN-Rail/surface
Pepperl + Fuchs	Z528/Ex	-ve	DIN-Rail/surface
MTL	MTL728+	+ve	Busbar
MTL	MTL7028+	+ve	DIN-Rail
MTL	MTL7128+	+ve	DIN-Rail

Galvanically Isolated Barrier

Galvanically isolated barriers are also referred to as 'transformer isolated dc repeaters', 'isolating interfaces' and 'transformer isolated current repeaters'. They differ from conventional shunt zener barriers in that they provide electrical isolation between the input (safe area) and the output (hazardous area). This is achieved by the use of a dc/dc converter on the input side which is connected to the hazardous area through a voltage and power limiting resistor/zener combination similar to a conventional barrier.

The galvanic isolation technique means that the circuit does not need a high integrity (safety) earth and that the I.S. circuit is fully floating. Earth leakage problems for fire control panel are therefore eliminated if this type of interface is used.

Galvanically isolated barriers are available as single or dual channel versions and are recommended for any application in which direct earth connections are not acceptable. The galvanically isolated barrier is a two-wire device which does not need an external power supply.

Table 2: Galvanic (Transformer Isolated) Barriers

Manufacturer	Type	No. of channels	Certificate No.
Pepperl + Fuchs	KDFO CS EX 1.51P	1	IECExBAS05.0004
MTL	MTL4061	2	Ex94C2040X
MTL	MTL5061	2	Ex94C2040X

Approved Safety Barriers

The system certification includes a generic specification for barriers.

The generic specification is:

Any shunt zener diode safety barrier certified by BASEEFA or any EEC approved certification body to

[Ex ia] IIC

Having the following or lower output parameters:

$$U_z = 28 \text{ V} = \frac{U_z}{R}$$

$$I_{\text{max:out}} = 93.3 \text{ mA}$$

$$W_{\text{max:out}} = 0.67 \text{ W}$$

In any safety barrier used the output current must be limited by a resistor 'R' such that

$$I_{\text{max:out}} = \frac{U_z}{R}$$

A number of shunt zener diode barriers meet this specification and examples are given in Table1.

Safety earth

Shunt zener diode safety barriers must be connected to a high integrity earth by at least one and preferably two copper cables, each of a cross-sectional area of 4 mm² or greater. The connection must be such that the impedance from the connection point to the main power system earth is less than one Ohm.

I.S. safe circuits in the hazardous area should be insulated from earth and must be capable of withstanding a 500 V RMS ac test voltage for at least one minute. When using armoured or copper sheathed cables, the armour or sheath is normally isolated from the safe area bus-bar.

Maximum loading of I.S. circuit

Because of the finite resistance of the safety barrier, there will be a limit to the current drain which can be tolerated before the voltages on the circuit fall outside the specified limits for Orbis I.S. devices. The system certification enables up to 20 Orbis I.S. detectors to be connected to a single barrier circuit with an end-of-line resistor of not less than 1.8 kΩ. However, it must be ensured that the voltage available at each detector is above the minimum specified in the quiescent condition. It is also important to ensure that the alarm load is suitable for the fire control panel. The system certification also allows the use of remote LED indicators. These may be connected to individual detectors or may use a connection common to two or more detectors.

Table 3: Limits for energy stored in cables

Group	Capacitance μF	Inductance mH	L/R ratio μH/Ohm
IIC	0.083	4.2	55
IIB	0.65	12.6	165
IIA	2.15	33.6	440

To calculate the total capacitance or inductance for the length of cables in the hazardous area, refer to Table 4, which gives typical per kilometre capacitance and inductance for commonly used cables.

Note: All Orbis I.S. devices have zero equivalent capacitance and inductance.

Table 4: Examples of electrical characteristics of cables commonly use in fire protection systems

Cable type	Core	Size mm ²	Conductor resistance Ohm/km/core	Inductance mH/km	Capacitance μF/km		Sheath resistance Ohm/km
					core to core	core to sheath	
MICC Pyrotenax light duty	2	1.5	12.1	0.534	0.19	0.21	2.77
MICC Pyrotenax heavy duty	2	1.5	12.1	0.643	0.13	0.17	1.58
Pirelli FP200	all	1.5	12.1	-	0.38	0.15	-
PVC sheathed and insulated to BS 6004	all	1.5	12.1	0.77	0.09	-	-

Wiring and cable types

It is not permitted to connect more than one circuit in the hazardous area to any one safety barrier and that circuit may not be connected to any other electrical circuit. Both separate and twin cables may be used. A pair contained in a type 'A' or 'B' multi-core cable (as defined in Clause 12.2.2 of BS EN 60079-14) may also be used, provided that the peak voltage of any circuit contained within the multi-core does not exceed 60 V.

The capacitance and either the inductance or the inductance to resistance (L/R) ratio of the hazardous area cables must not exceed the parameters specified in Table 3. The reason for this is that energy can be stored in a cable and it is necessary to use cable in which the energy stored is insufficient to ignite an explosive atmosphere.

Installation

It is important that the Orbis I.S. detectors are installed in such a way that all terminals and connections are protected to at least IP20 when the detector is in the base. Special care must be taken with the rear of the mounting base where live metal parts may be accessible. Flush mounting of the base on a flat surface will provide the required degree of protection.

The conduit box, Apollo Part No. 45681-204, is also acceptable for use when mounting I.S. bases. Apollo also supply a range of deckhead mounting boxes. More information can be found in the 'Mounting Accessories' section of this publication.

Note: The earth terminal in the Orbis I.S. base is provided for convenience where continuity of a cable sheath or similar is required. It is not necessary for the correct operation of the detector, nor is it provided as a termination point for a safety earth.



Intrinsically Safe Base Wiring Guide

1. Activate the locking mechanism if the detector is to be locked into the base. To do this, remove the small portion of plastic shown in Fig 1 with side cutters or similar tool.
2. Partially screw two screws into the mounting box or soffit at the required centres. Place the corresponding slots of the base over the screws and slide the base home. Tighten up the screws.

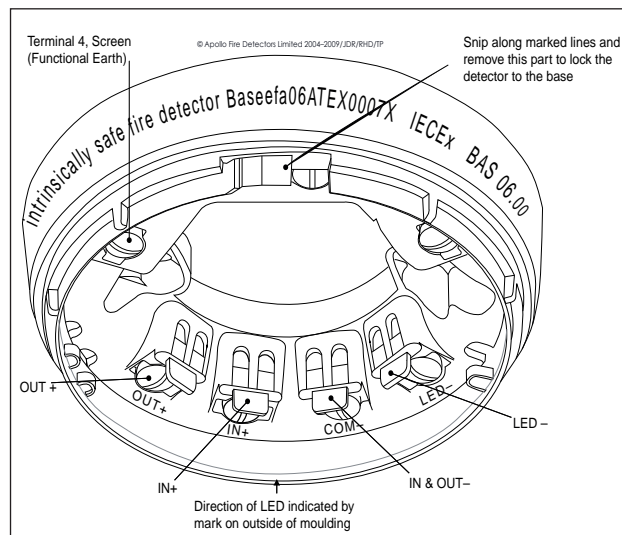

Fig 1 Orbis IS base terminals

3. Fig 1 shows the wiring terminals. The terminal marked '4' on the base is provided for connecting the screen or functional earth.

Apollo Fire Detectors Limited, 36 Brookside Road, Havant, Hants, PO9 1JR, UK
Tel +44 (0)23 9249 2412 Fax +44 (0)23 9249 2754
Email: techsales@apollo-fire.co.uk



Intrinsically Safe Base Wiring Guide

1. Activate the locking mechanism if the detector is to be locked into the base. To do this, remove the small portion of plastic shown in Fig 1 with side cutters or similar tool.
2. Partially screw two screws into the mounting box or soffit at the required centres. Place the corresponding slots of the base over the screws and slide the base home. Tighten up the screws.

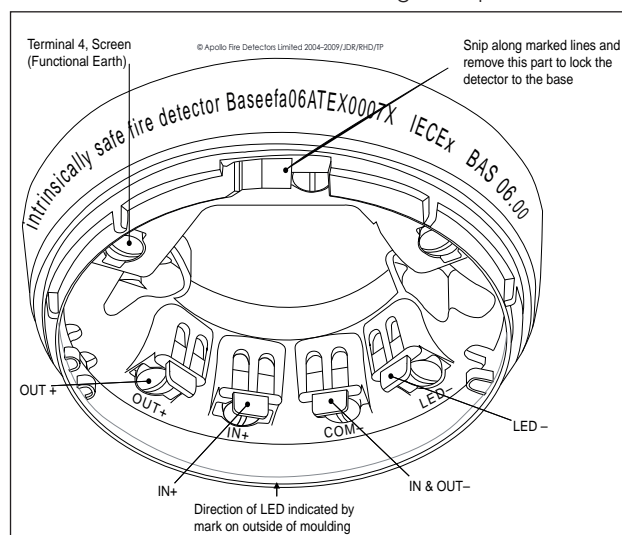

Fig 1 Orbis IS base terminals

3. Fig 1 shows the wiring terminals. The terminal marked '4' on the base is provided for connecting the screen or functional earth.

Apollo Fire Detectors Limited, 36 Brookside Road, Havant, Hants, PO9 1JR, UK
Tel +44 (0)23 9249 2412 Fax +44 (0)23 9249 2754
Email: techsales@apollo-fire.co.uk



4. The outside of the base is marked with a moulded vertical line to indicate the position of the LED when the detector has been fitted. This facilitates detector orientation if required.
5. When all the bases have been fitted a voltage test for wiring continuity may be carried out. The base is fitted with a continuity link which automatically opens when a detector is fitted to the base for the first time.

Fig 2 Wiring diagram for Orbis IS bases with one MiniDisc remote LED

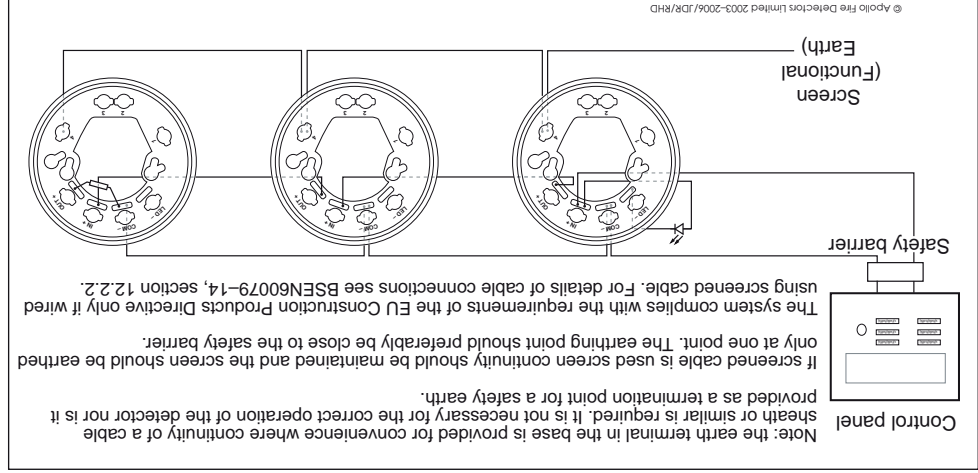

To unlock the detector from the base, insert a 1.5mm hexagonal driver (part no 29600-095) gently lever the driver outward whilst rotating the detector anti-clockwise.

For technical data refer to Product Guide PP2250 available on request.

Fig 3 Wiring diagram for Orbis IS bases with a common MiniDisc remote LED

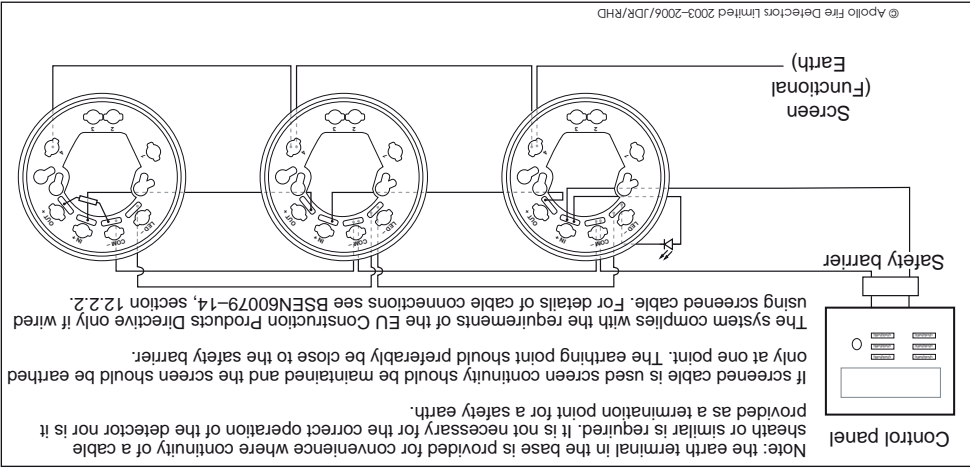

To unlock the detector from the base, insert a 1.5mm hexagonal driver (part no 29600-095) gently lever the driver outward whilst rotating the detector anti-clockwise.

For technical data refer to Product Guide PP2250 available on request.

Fig 3 Wiring diagram for Orbis IS bases with a common MiniDisc remote LED

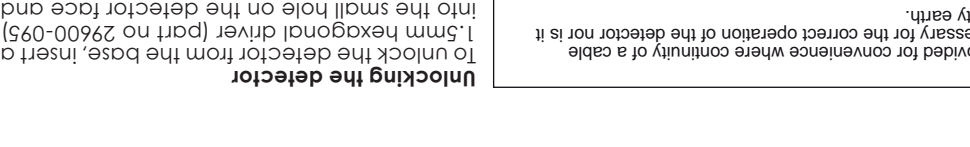
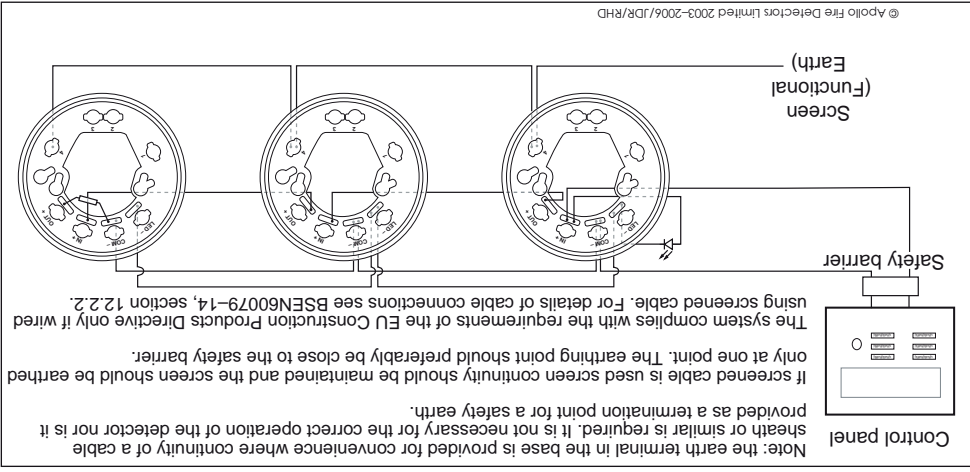

Fig 3 Wiring diagram for Orbis IS bases with a common MiniDisc remote LED



If screened cable is used screen continuity should be maintained and the screen should be earthed only at one point. The earthing point should preferably be close to the safety barrier.

The system complies with the requirements of the EU Construction Products Directive only if wired using screened cable. For details of cable connections see BSEN60079-14, section 12.2.2.